



**National Power Corporation**  
**REQUEST FOR QUOTATION**  
**(SMALL VALUE PROCUREMENT - 53.9)**

30 May 2024

Sir/Madam:

Please provide us with your best quotation for the items as specified in the Terms of Reference (TOR) for PR No. **S1-PAN24-005** Ref. No. SVP240614-CM and submit the same in a sealed envelope to be dropped in the designated drop box at the Bids and Contracts Services Division (BCSD), Ground Floor, Diliman, Quezon City **on or before 9:30 AM of 14 June 2024.**

The following documents must be submitted together with your quotation:

1. PhilGEPS Registration, whichever is applicable:

For Platinum Members:

2. Valid and Updated Certificate of PhilGEPS Registration (This should include the attached "Annex A"). In case the Mayor's Permit in the said Annex "A" is expired, a valid/updated Mayor's Permit must also be submitted.

For Red or Blue Members:

- Valid Mayor's Permit showing the expiry date;
- PhilGEPS Registration Number

1. Other documents: **Additional documents to be submitted during Post-Qualification**  
*(Please refer to the attached TOR)*

Additional Documentary Requirements, if applicable:

- Omnibus Sworn Statement (use attached Form) (For Total ABC of Above PhP 50,000);
- Latest Income Tax Return / Business Tax Return (For Total ABC of Above PhP 500,000);
- Professional License/Curriculum Vitae (for Consulting Services only);
- PCAB License (for INFRA Projects only);

The Warranty Period shall be: Please refer to the attached TOR.

In case of a failed bidding, a re-bidding maybe conducted without prior notice to any previous bidder(s).

For further inquiries, please contact the BAC Secretariat, **Mr. Christian Cley D. Merle** at telephone no/s. 8 - 921-3541 loc 5611 / with e-mail address at [christiancley.napocor@gmail.com](mailto:christiancley.napocor@gmail.com).

Very truly yours,

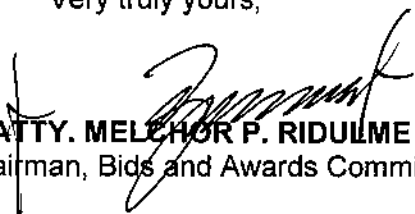
  
**ATTY. MELCHOR P. RIDULME**  
Chairman, Bids and Awards Committee



**NATIONAL POWER CORPORATION**  
Gabriel Y. Itchon Building  
Senator Miriam P. Defensor-Santiago Avenue (formerly BIR Road)  
corner Quezon Avenue, Diliman, Quezon City 1100, Philippines  
Tel. Nos. (632) 8921-3541 to 80 • Fax No. (632) 8921-2468  
Website: [www.napocor.gov.ph](http://www.napocor.gov.ph)





Republic of the Philippines  
NATIONAL POWER CORPORATION

**TERMS OF REFERENCE  
ALTERNATIVE MODE OF PROCUREMENT  
(SMALL VALUE PROCUREMENT – 53.9)**

1. **Scope of Works:** PR NO. S1-PAN24-005/REF NO. SVP240614 - CM

**FOR THE SUPPLY OF LABOR, TOOLS AND MATERIALS FOR THE CONSTRUCTION OF  
GENSET ROOF SHED AT PANLAITAN DPP**

Item No.	DESCRIPTION	QTY.	U/M	ABC (Php)
1	SUPPLY OF LABOR, TOOLS AND MATERIALS FOR THE CONSTRUCTION OF GENSET ROOF SHED AT PANLAITAN DPP	1	LOT	800,000.00
<b>TOTAL</b>				<b>800,000.00</b>

Notes:

- See attached sheet for complete Technical Specification.
- Updated Mayor's Permit and PhilGeps Registration.
- Bidders are required and reminded to strictly state/include in their own Bid Proposal the requirements in the Terms and Conditions stated under the NPC Terms of Reference (TOR) to wit:
  - Payment Terms
  - Delivery Period
  - Price Validity
  - Delivery Point

**APPROVED BUDGET FOR THE CONTRACT: PHP 800,000.00**

**2. Delivery Period**

Delivery Period shall not be later than **Sixty (60) CALENDAR DAYS** upon receipt of the Notice to Proceed.

**3. Delivery Point**

Items shall be delivered to the **Panlaitan Diesel Power Plant, Brgy. Panlaitan, Busuanga, Palawan.**

**4. Bid Submission**

The Bidder shall submit their bids through their authorized representative or in the manner of submission as prescribed in the RFQ.

**5. Late Bids**

Any Bid submitted after the deadline for submission and receipt of Bids shall not be accepted by NPC.

## **6. Bid Prices**

The bid price as indicated in the Quotation Form shall be fixed during the Bidder's performance of the Contract and not subject to variation or price escalation on any account. A Bid submitted with an adjustable price quotation shall be treated as non-responsive.

## **7. Bid Price Validity**

Price Validity shall not be less than One Hundred Twenty (120) calendar days from date of bid submission.

## **8. Eligibility Criteria**

- a. Bids shall be checked using the PASS / FAIL Criteria for Legal, Technical and Financial components.
- b. From the bids that were rated PASSED, the same shall be ranked and corrected for computational errors to identify the Lowest Calculated Quotation (LCQ).

## **9. Detailed Evaluation and Comparison of Bids**

The LCQ shall be subjected to detailed evaluation against the Technical Specifications including arithmetical computations. Documents which are deemed not to comply with the requirements of the tender shall be considered non-complying.

## **10. Post-qualification**

Submitted documents of the LCQ shall be subjected to post qualification evaluation. The bid that PASSED the Post-Qualification shall be declared as the Lowest Calculated Responsive Quotation (LCRQ).

## **11. Total Contract Price**

The Total Contract Price shall be inclusive of all taxes and other related expenses / charges.

## **12. Notice to Supplier**

- a. The supplier shall pick-up the Purchase Order (PO)/ Notice to Proceed (NTP) from NPC within two (2) calendar days from receipt of the Notice of Award.
- b. Failure to secure the PO/NTP by the supplier within the said period will mean cancellation of the same and imposition of penalties as prescribed by law.

## **13. PO Effectivity**

- a. The PO Shall take effect immediately upon receipt of the PO / NTP by the supplier sent through fax as evidenced by the fax transmission receipt and as confirmed by the supplier's representative.

## **14. Terms of Payment**

Terms of Payment shall be sixty (60) calendar days after submission of complete supporting documents.

## **15. Warranty**

Warranty shall be based on scope of works.

## **16. Liquidated Damages**

Where the supplier refuses or fails to satisfactorily complete the work within the specified contract time, plus any time of extension duly granted and is hereby in default under the contract, the supplier shall pay NPC for liquidated damages, and not by way of penalty, an amount equal to at least one tenth (1/10) of one percent (1%) of the cost of the undelivered/unperformed portion of the items/works for every day of delay. Once the cumulative amount of liquidated damages reaches ten percent (10%) of the amount of the contract, the procuring entity may rescind or terminate the contract, without prejudice to other courses of action and remedies open to it (Section 68 of the Revised IRR of RA 9184).

## **17. Liability of the Supplier**

If after receipt of the Purchase Order, the supplier fails to deliver the goods, appropriate sanctions will be imposed as prescribed under Republic Act (RA) 9184 and its Revised Implementing Rules and Regulations (IRR).

## **18. Disclosure of Relations**

The bidder shall comply with the provisions of Section 47 of RA 9184 and its revised IRR re: disclosure of relations.

## **19. Administrative Sanctions**

Bidder shall likewise be imposed the rules as stated in section 69 (Imposition of administrative penalties) should there be infractions committed.

## **20. Reservation Clause**

NPC reserves the right to accept or reject any bid, to annul the bidding process, and to reject all bids at any time prior to contract award, without thereby incurring any liability to the affected bidder/s

-----remaining spaces are intentionally left blank -----

**SUPPLIER'S BID QUOTATION  
(SMALL VALUE PROCUREMENT – 53.9)**

To: The BAC Chairman:

I have read and examined the Terms of Reference for Purchase Requisition (PR) No/s. **S1-PAN24-005**. I agree with the conditions of the TOR and offer the following supplies with specific description:

ITEM NO.	DESCRIPTION OF ITEM / S TO BE SUPPLIED (INCLUDE BRAND NAME)	QTY	UNIT PRICE (PhP)	TOTAL PRICE (PhP)
<b>TOTAL BID PRICE</b>				

\_\_\_\_\_  
Name and Signature of Authorized Representative

Date \_\_\_\_\_

Company Name \_\_\_\_\_

Contact Details \_\_\_\_\_

e-mail address \_\_\_\_\_

*Note: The bidder may use this form or its own company letter head following this format duly signed by the authorized representative when making the offer.*



Republic of the Philippines  
NATIONAL POWER CORPORATION

**TERMS OF REFERENCE  
ALTERNATIVE MODE OF PROCUREMENT  
(SMALL VALUE PROCUREMENT – 53.9)**

**1. Scope of works: PR NO. S1-PAN24-005/REF NO: \_\_\_\_\_**

Supply of Labor, Tools and Materials for the Construction of Genset Roof Shed at Panlaitan DPP

**SCOPE OF WORKS**

1. Preparation, consolidation and completion of materials, tools and equipment needed for the construction. *(Note: There is no Hardware in the island.)*
2. Delivery of materials, tools and equipment to Plant site.
3. Excavation, construction, installation/erection of Genset Roof Shed with the additional provision of concreting the flooring of the portion labeled "PORTION A" in the attached design. With the construction in accordance with the specifications and dimensions of materials as well as the dimensions of the area as stated in the design. *See attached Genset Roof design for reference.*
4. Construction works shall be duly monitored by designated NPC POD representative at plant site.
5. Winning bidder shall be responsible for payment of all materials, labor, equipment necessary for the completion of this activity.
6. The corporation is not liable to any damages or physical injuries that may arise from the foregoing activities.
7. Bid winner shall be responsible for the cleanliness and housekeeping of the area during and after completion of each day to day activity for the whole duration of the construction.
8. Provision of One (1) year warranty on labor and materials.

*Note/s: A. All materials/items to be supplied by the winning bidder/s should be brand new, genuine and in its original packaging.*

---

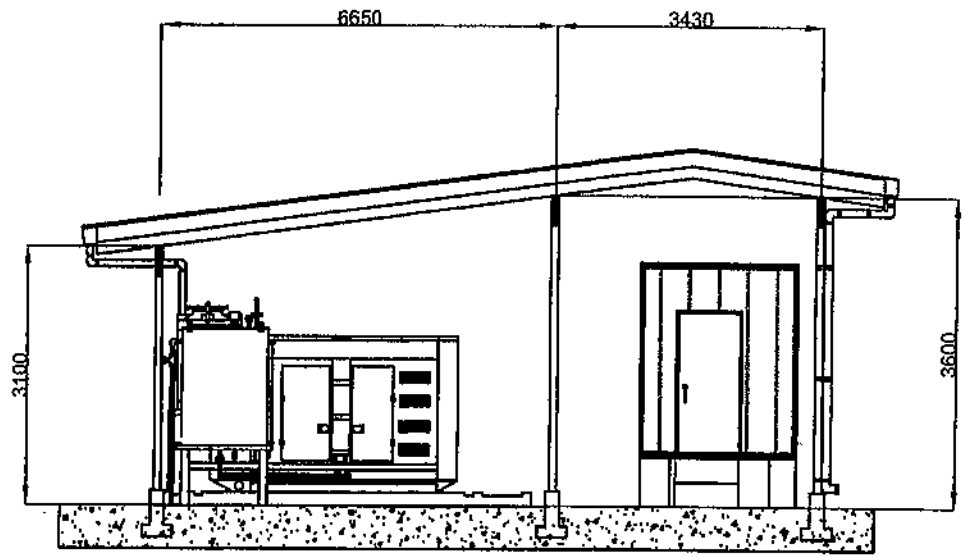

GENSET ROOFING SHED FOR 1 X 100 KW GENSET AT PANLAITAN DPP



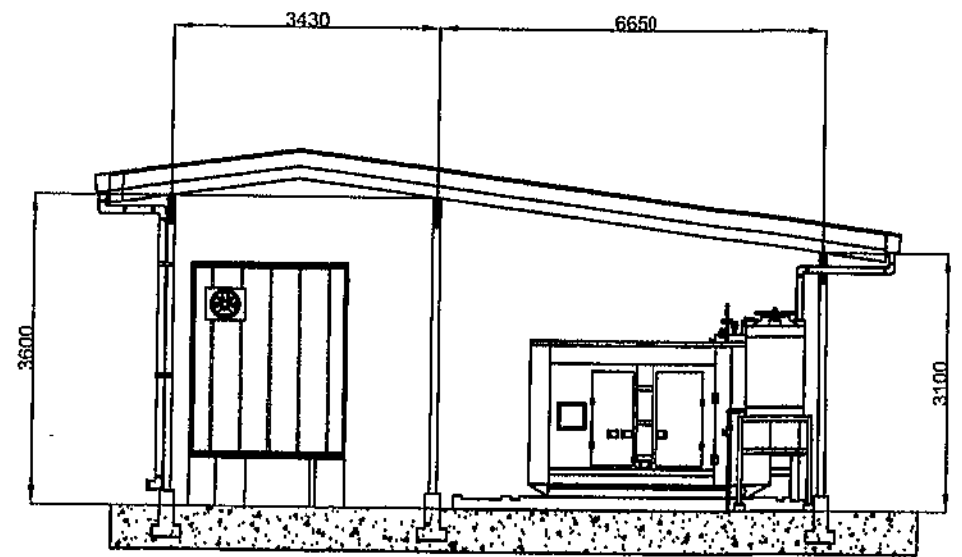



SIDE VIEW

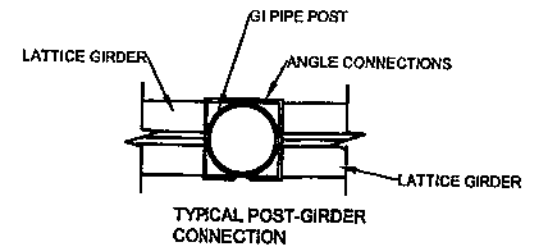
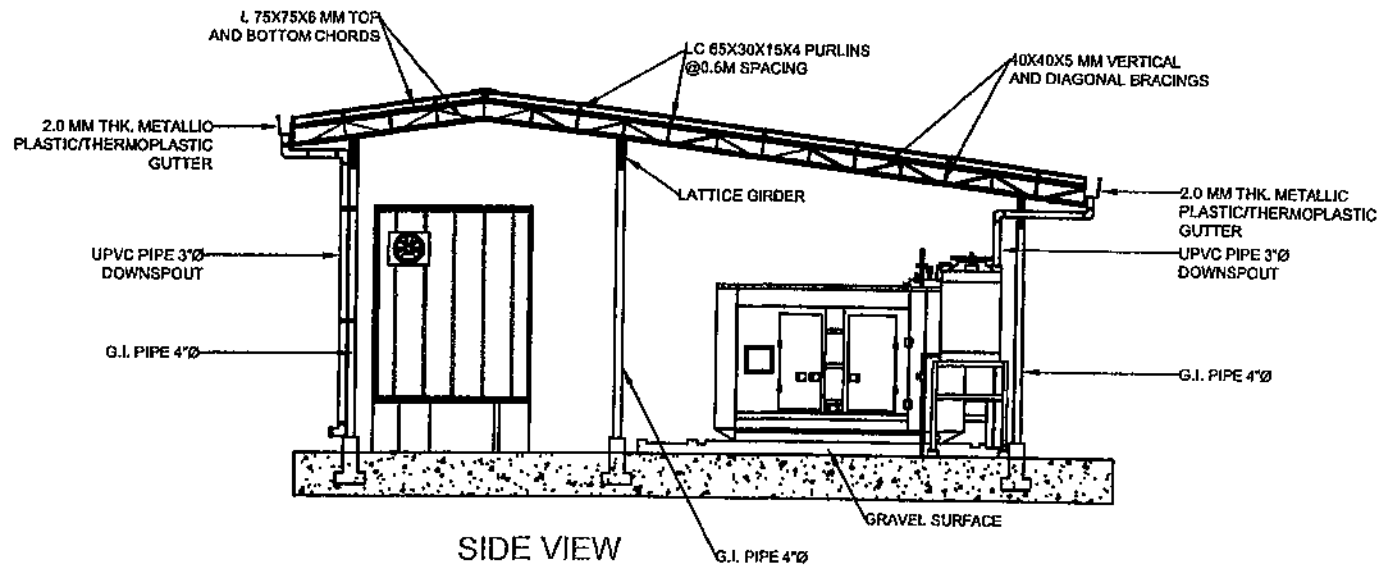
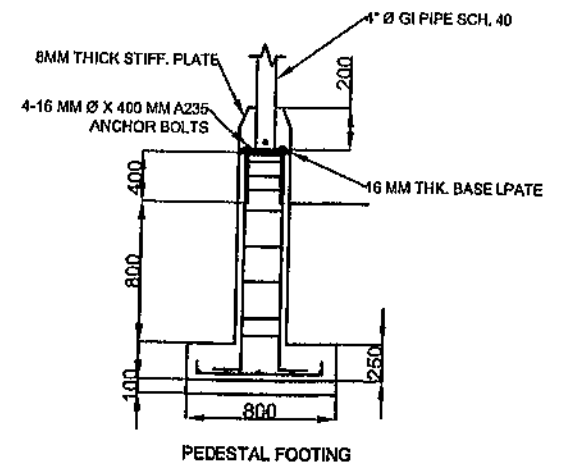
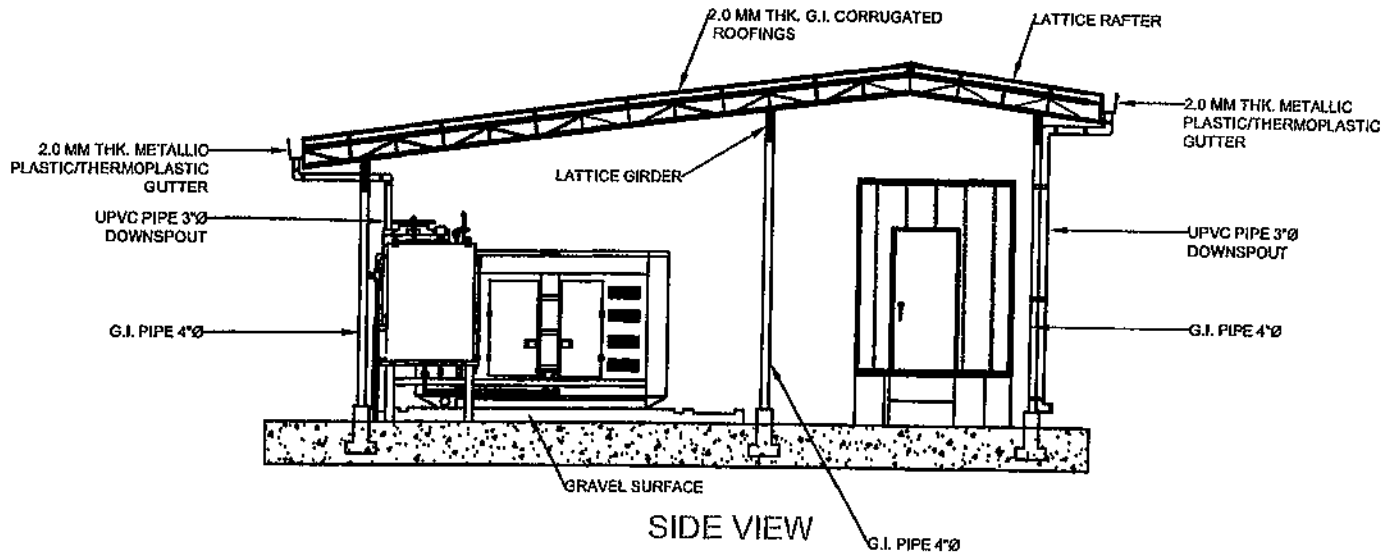

SIDE VIEW

 NATIONAL POWER CORPORATION SMALL POWER UTILITIES GROUP LUZON OPERATIONS DEPARTMENT PALAWAY AREA OPERATIONS DIVISION		CONSTRUCTION OF GENSET ROOFING SHED FOR 1 X 100 KW GENSET AT PANLAITAN DPP	
		PANLAITAN DIESEL DIESEL POWER PLANT BGY, PANLAITAN, BUSUJANGA, PALAWAN	
DRAFTED:  J.D.G. PADUGA ENGINEER	DATE: MAY 7, 2024	REVISION: SHEET	1 5
APPROVED:  P.B. BARRIOS MANAGER, EOD	DRAWING NUMBER: PAN24-WO-001		



 <b>NATIONAL POWER CORPORATION</b> SMALL POWER UTILITIES GROUP LUZON OPERATIONS DEPARTMENT PALAWAN AREA OPERATIONS DIVISION			
DRAFTED:  <b>J.D.G. PADUGA</b> ENGINEER II	CONSTRUCTION OF GENSET ROOFING SHED FOR 1 X 100 KW GENSET AT PANLAITAN DPP		
	PANLAITAN DIESEL POWER PLANT BSY, PANLAITAN, BUSBUANGA, PALAWAN		
APPROVED:  <b>F.B. BARRIOS</b> MANAGER/POD	DATE: MAY 7, 2024	REVISION:	SHEET: 2
	DRAWING NUMBER: PAN24-WO-001		5



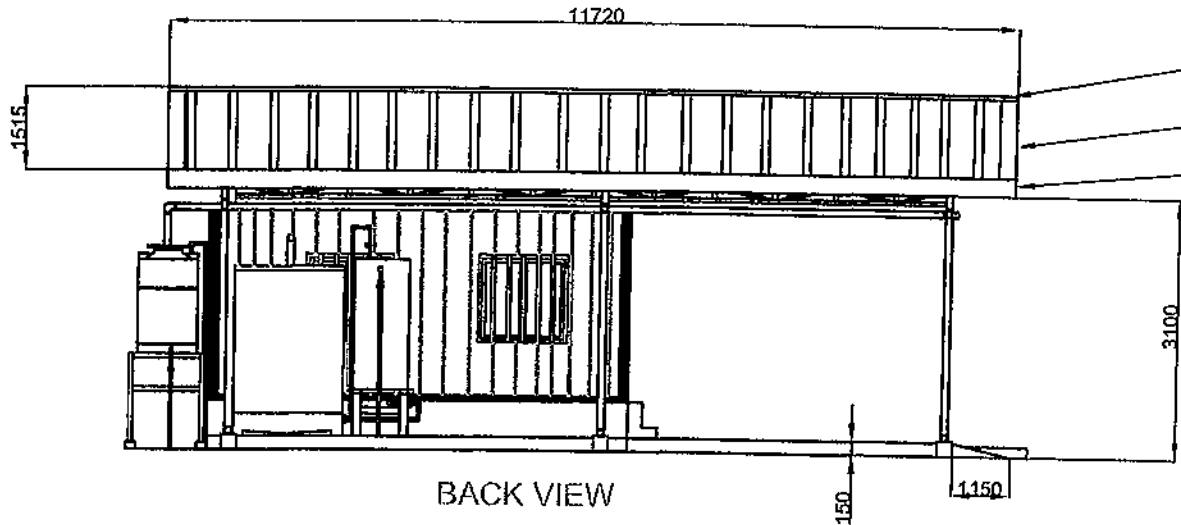

BACK VIEW

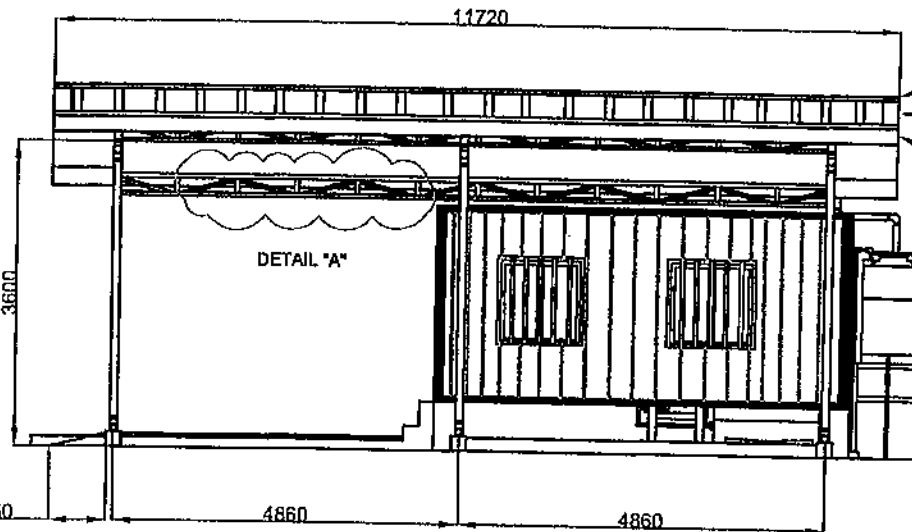

- 2.0 MM THK. GALVANIZED RIDGE ROLL
- 2.0 MM THK. G.I. CORRUGATED ROOFINGS
- 2.0 MM THK. METALLIC PLASTIC/THERMOPLASTIC ROOFINGS

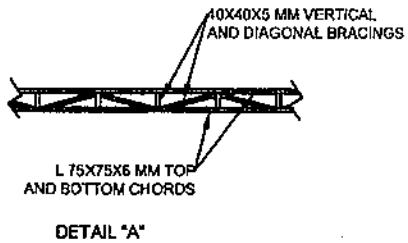

FRONT VIEW

- 2.0 MM THK. GALVANIZED RIDGE ROLL
- 2.0 MM THK. G.I. CORRUGATED ROOFINGS
- 2.0 MM THK. METALLIC PLASTIC/THERMOPLASTIC ROOFINGS



 <b>NATIONAL POWER CORPORATION</b> SMALL POWER UTILITIES GROUP LUZON OPERATIONS DEPARTMENT PALAWAN AREA OPERATIONS DIVISION			
DRAFTED:  <b>J.D.G. PADUGA</b> ENGINEER II		CONSTRUCTION OF GENSET ROOFING SHED FOR 1 X 100 KW GENSET AT PANLAITAN DPP	
APPROVED:  <b>F. B. BARRIOS</b> MANAGER PDD		DATE: MAY 7, 2024	REVISION: SHEET 3 / 5
		DRAWING NUMBER: PAN24-WO-001	

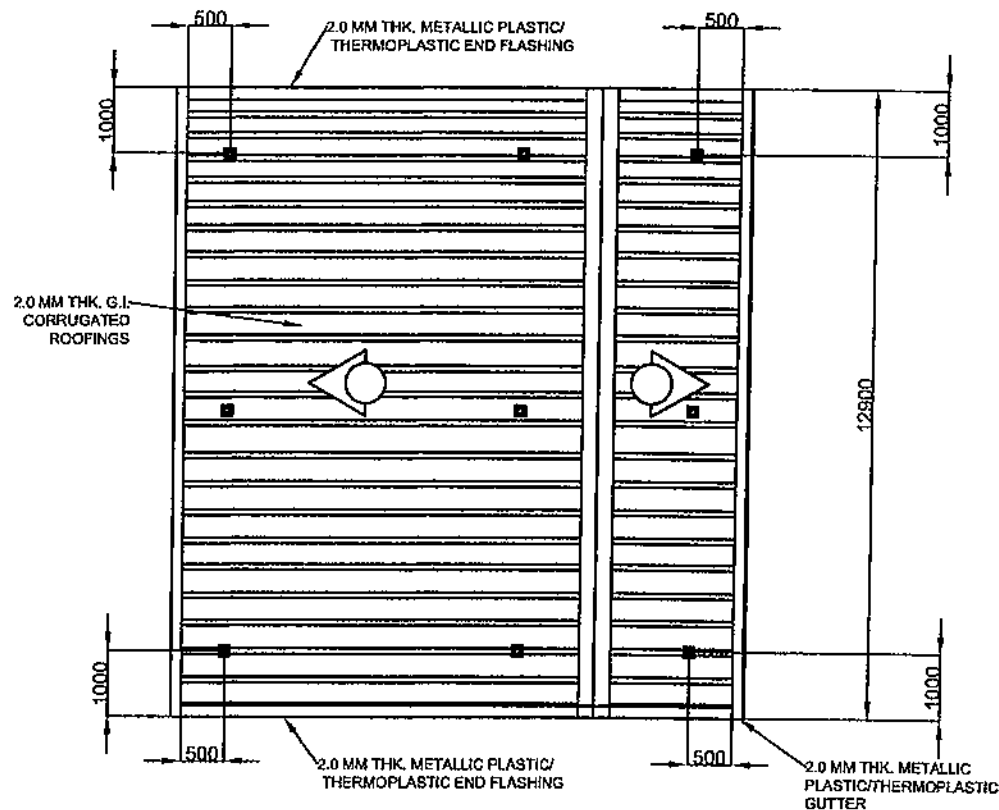

ROOFING DETAILS

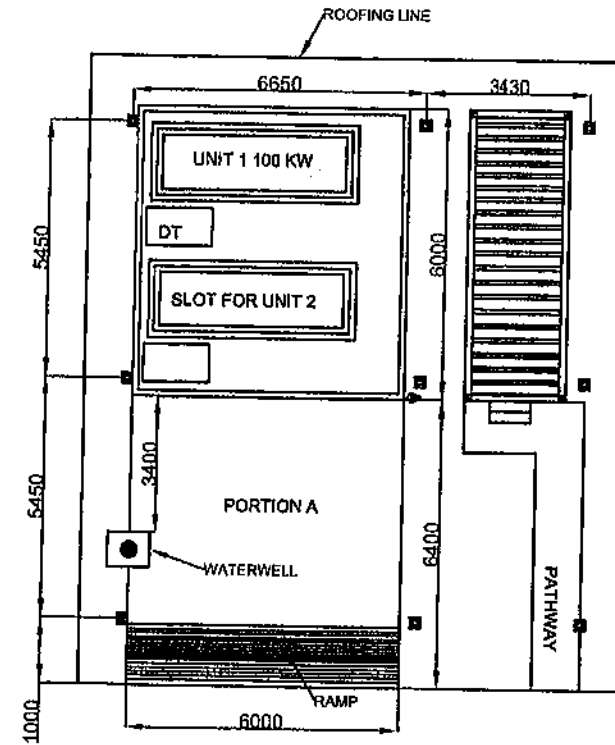

TOP VIEW

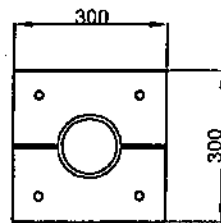

BASE PLATE PLAN

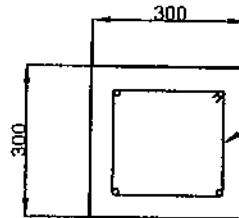

PEDESTAL PLAN



4-12 MM Ø VERT. BARS W/ 10 MM Ø TIES  
SPACED 1 @ 50MM, 1 @ 100 MM, REST @  
200 MM FROM SUPPORT TO MIDHEIGHT

 <b>NATIONAL POWER CORPORATION</b> SMALL POWER UTILITIES GROUP LUZON OPERATIONS DEPARTMENT PALAWAN AREA OPERATIONS DIVISION		CONSTRUCTION OF GENSET ROOFING BHED FOR 1 X 100 KW GENSET AT PANLAITAN DPP	
		PANLAITAN DIESEL DIESEL POWER PLANT BGY. PANLAITAN, BUSUANGA, PALAWAN	
DRAFTED:	<i>J.D.G.</i>	DATE:	REVISION:
	J.D.G. PADUGA ENGINEER II	MAY 7, 2024	4
APPROVED:	<i>F.B.</i>	DRAWING NUMBER:	SHEET
	F. B. BARRIOS MANAGER, POD	PAN24-WO-001	5

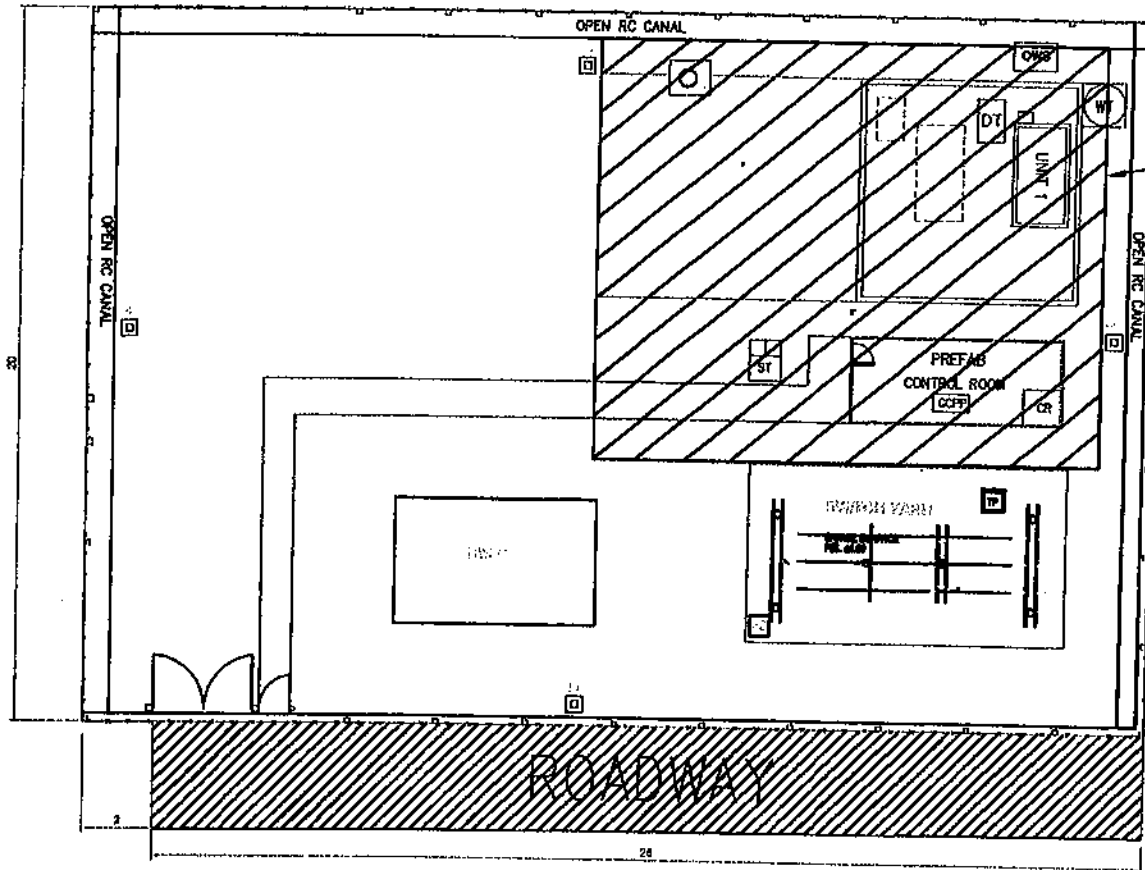
PLANT LAYOUT WITH GENSET ROOFING SHED FOR 1 X 100 KW GENSET AT PANLAITAN DPP



COVERAGE AREA  
FOR ROOFING OF  
GENSET  
(L X W = 12.9M X 10.58M)

 <b>NATIONAL POWER CORPORATION</b> SMALL POWER UTILITIES GROUP LUZON OPERATIONS DEPARTMENT PALAWAN AREA OPERATIONS DIVISION		CONSTRUCTION OF GENSET ROOFING SHED FOR 1 X 100 KW GENSET AT PANLAITAN DPP	
		PANLAITAN DIESEL DIESEL POWER PLANT BGY. PANLAITAN, BUSUWAGA, PALAWAN	
DRAFTED:	 <b>J.D.G. PADUGA</b> ENGINEER II	DATE:	MAY 7, 2024
APPROVED:	 <b>F. B. BARRIOS</b> MANAGER POD	REVISION:	SHEET
		DRAWING NUMBER:	PAN24-WO-001
			5
			5