

**ENVIRONMENTAL AND SOCIAL MANAGEMENT PLAN**  
**ASEP - RURAL NETWORK SOLAR (RNS)**  
**ILOCOS NORTE ELECTRIC COOPERATIVE, INC. (INEC)**

I. Project Description

- a. Name: Currimeo Solar Power Project
- b. Type: Solar Power Plant
- c. Purpose: To comply RPS requirement
- d. Capacity: 1MW
- e. Location: Brgy. Lang-ayan Currimeo, Ilocos Norte
- f. Land Area: 14,219 sq. meters
- g. Footprint: \_\_\_\_\_
- h. Components/Structure: Solar PV Modules, Solar Frame & Mounting System, String, Combiner Box, Solar Inverter
- i. Source of Water: Ground Water (With existing deep well)
- j. Wastes to be generated: Construction Debris
- k. Useful Life in years: 15 – 30 years
- l. Beneficiaries and Benefits: Serves as a power supply for Circuit 7 & 8

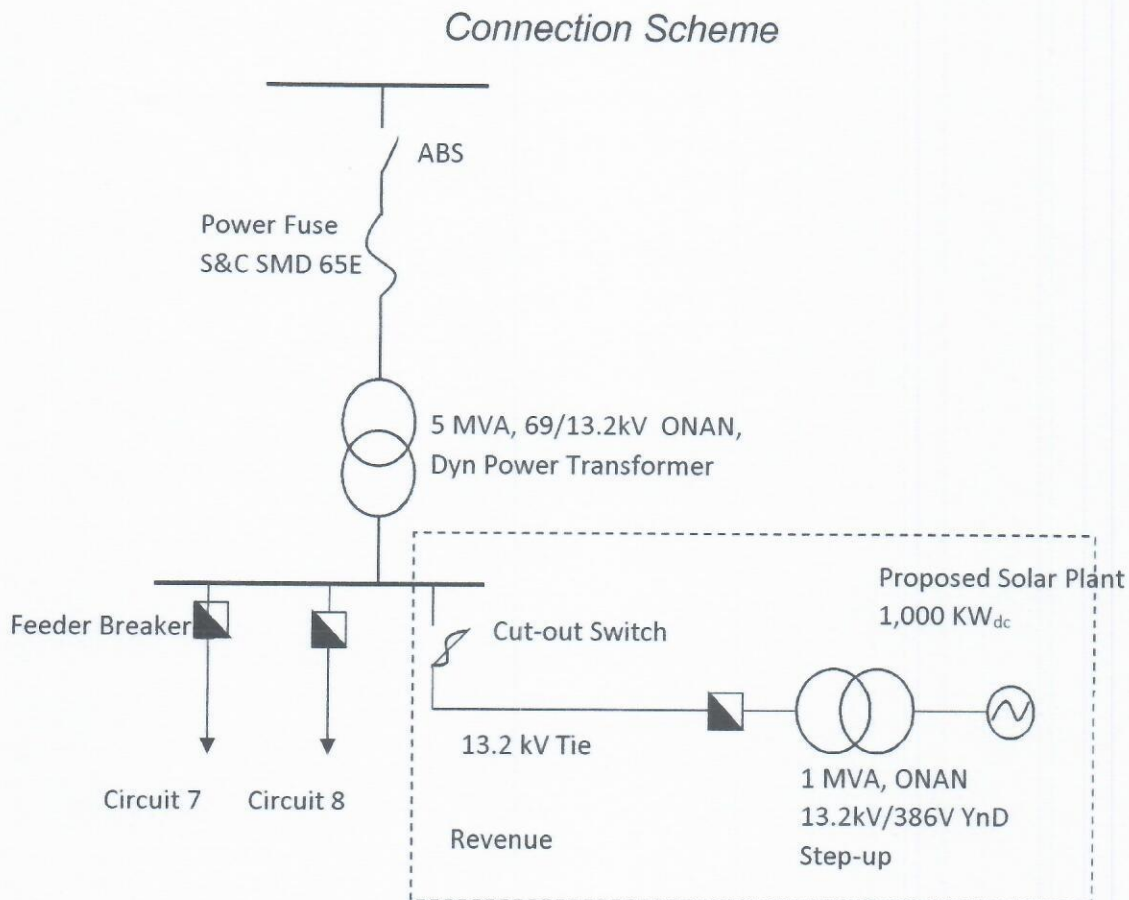



d. Vegetation Type (at the site): Grassland

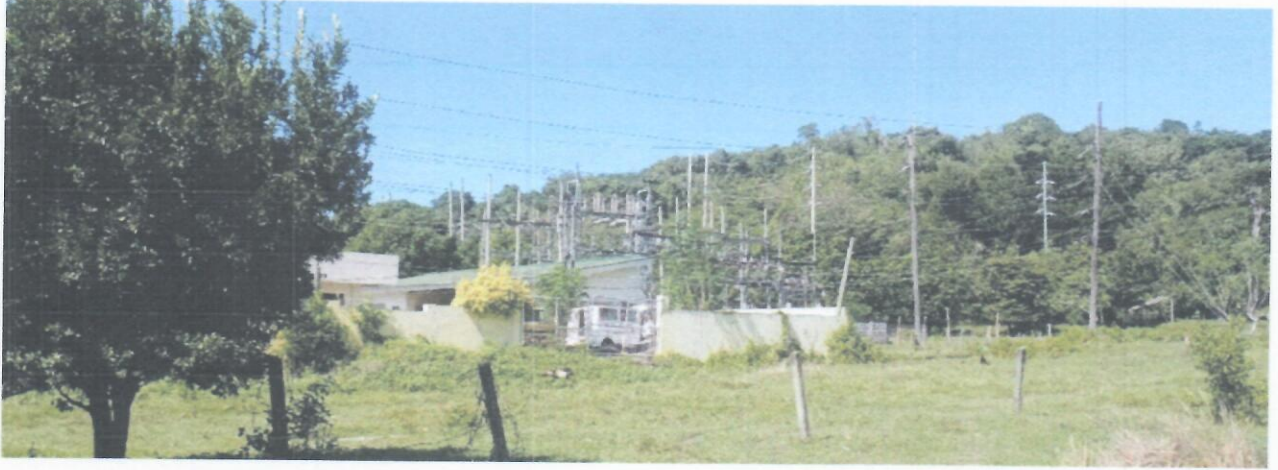



## SITE OF THE RNS SOLAR FARM – ILOCOS NORTE ELECTRIC COOPERATIVE

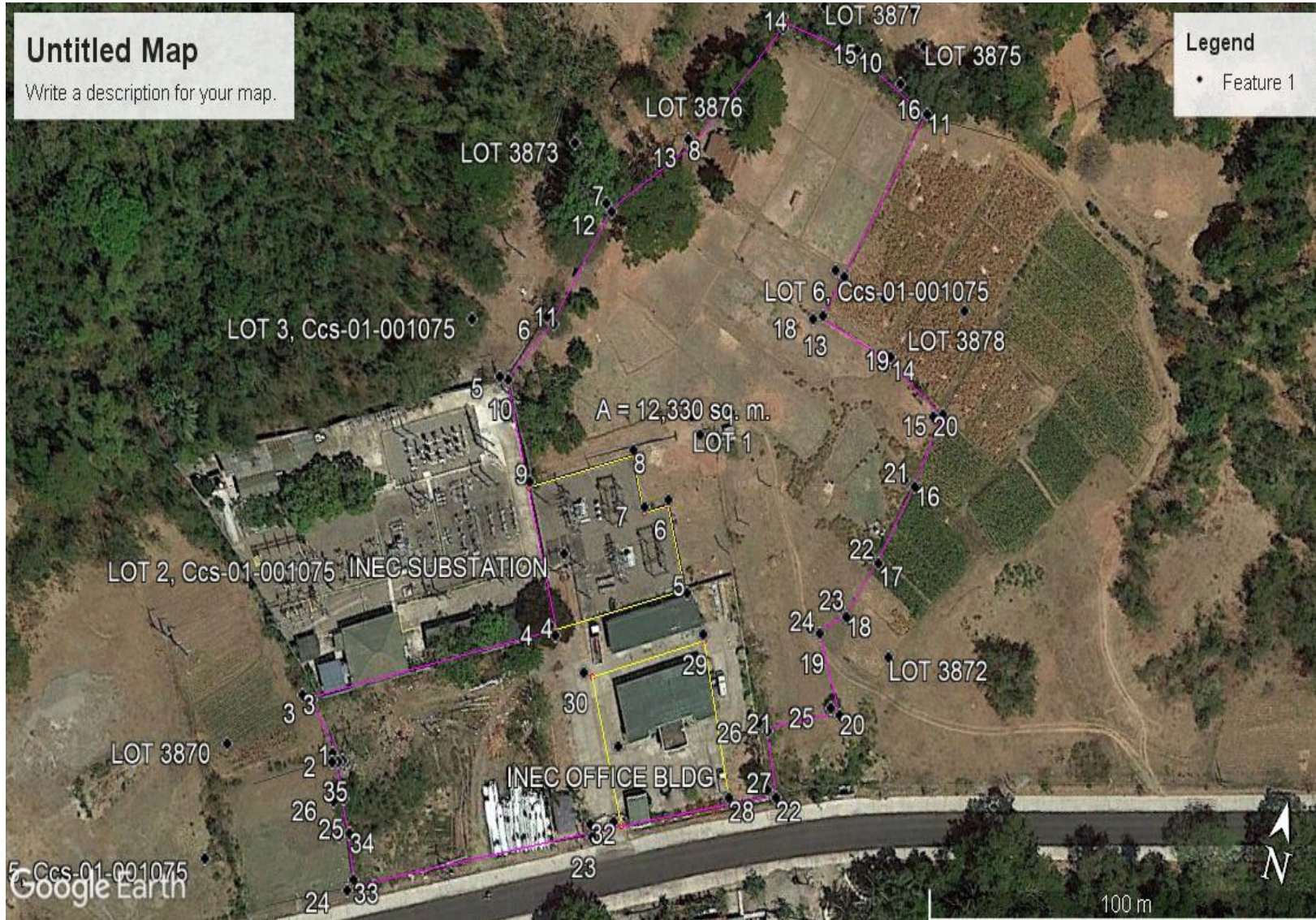

The solar farm will be constructed within INEC lot with boundaries indicated by the purple outline. The lot has a total area of 1.4219 hectares but only 1.233 hectares are allocated for the solar farm. Portions of the lot delineated by yellow outline and occupied by existing structures (owned by INEC) are excluded.



**Photos of the INEC RNS Project Site**  
taken during NPC Site Visit 11-29-19









## Actual Land Use at the INEC RNS Project Site and Vicinities

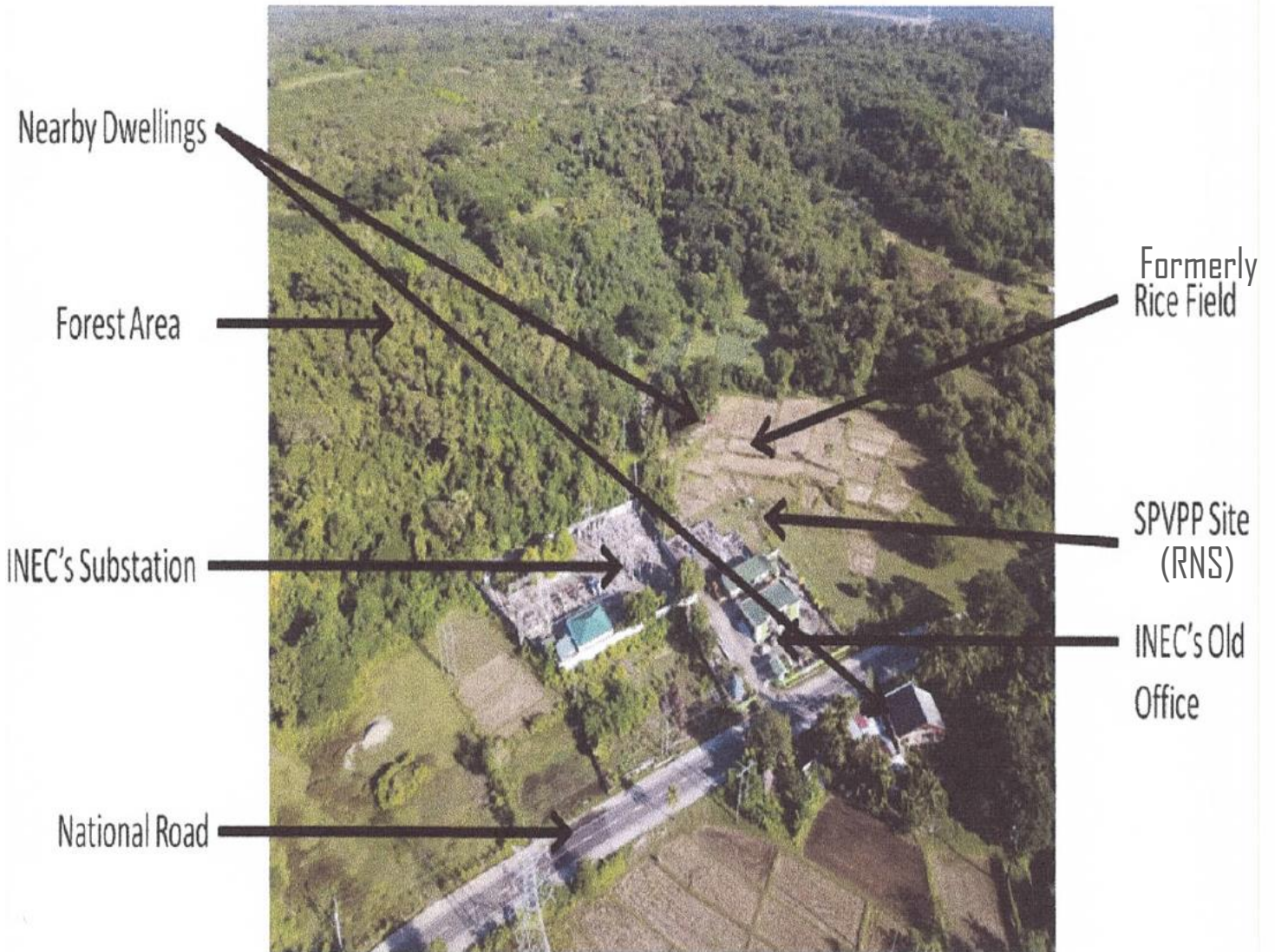

**ENVIRONMENTAL AND SOCIAL MANAGEMENT PLAN**  
**ACCESS TO SUSTAINABLE ENERGY PROJECT - RURAL NETWORK SOLAR**  
*ILOCOS NORTE ELECTRIC COOPERATIVE, INC.*

Project Phase	Activity	Environmental Issues/Potential Impacts	Mitigation Measures	Institutional Responsibility		Accomplishments For the period _____		
				Implementation	Supervision	Specific Measures Implemented	Date/Period Implemented	Proof of Compliance/Implementation
PRE-CONSTRUCTION	<ul style="list-style-type: none"> <li>▪ Stakeholder engagement</li> <li>▪ Coordination with LGU, regulatory &amp; other gov't agencies</li> <li>▪ Coordination with Contractors</li> </ul>	<ul style="list-style-type: none"> <li>▪ Exposure of EC's workers and the community to Covid19 virus</li> </ul>	<ul style="list-style-type: none"> <li>▪ Minimize face to face interaction</li> </ul>	INEC, LGUs, regulatory/ government agencies, Contractors, community	INEC's ESMP Focal person, NPC-PMO			
			<ul style="list-style-type: none"> <li>▪ Follow DOH health protocols for Covid19</li> </ul>			<ul style="list-style-type: none"> <li>▪</li> </ul>		
SITE PREPARATION	(clearing and perimeter fencing)	Exposure of soil to erosion due to clearing and excavation during fencing	<ul style="list-style-type: none"> <li>▪ Minimize area to be stripped of vegetation</li> </ul>	INEC, Contractor for fencing/ clearing	INEC's ESMP Focal person, NPC-PMO			
			<ul style="list-style-type: none"> <li>▪ Manage excavated soil to minimize sediments in surface runoff</li> </ul>					
			<ul style="list-style-type: none"> <li>▪ Place ripraps along the fence line, if needed</li> </ul>					
			<ul style="list-style-type: none"> <li>▪ Undertake proper landscaping where possible, and as soon as feasible, for natural soil protection from strong winds and soil erosion.</li> </ul>	INEC				
			<ul style="list-style-type: none"> <li>▪ Plant trees of native species within the site or in the vicinity, if possible.</li> </ul>					
	Site preparation (clearing and perimeter fencing)	<ul style="list-style-type: none"> <li>• Increase in airborne dust</li> </ul>	<ul style="list-style-type: none"> <li>▪ Spray water to reduce dust during dry weather</li> </ul>	INEC/ Contractor for clearing/ fencing				

*[Handwritten signatures]*



	<ul style="list-style-type: none"> <li>Possible nuisance to workers at the adjacent NGCP substation and nearby dwellers particularly the family dwelling within the INEC property due to dust from the site</li> </ul>	<ul style="list-style-type: none"> <li>Inform residents/workers in the adjacent areas about the activities to be undertaken and the schedule prior to project implementation</li> <li>Inform the community/public about INEC's Grievance Redress Mechanism for resolving project related complaints</li> </ul>	INEC	INEC's ESMP Focal person, NPC-PMO			
	<ul style="list-style-type: none"> <li>Power supply interruption due to relocation of 3 poles including distribution lines located within the project site</li> </ul>	<ul style="list-style-type: none"> <li>Plan relocation activities such that power interruption will affect only a few power consumers and only for a short duration</li> <li>Notify affected power consumers promptly about the scheduled power interruption</li> </ul>	INEC	INEC's ESMP Focal person, NPC-PMO			
	<ul style="list-style-type: none"> <li>Health and safety risks to site workers and the community</li> </ul>	<ul style="list-style-type: none"> <li>Follow DPWH Construction Safety Guidelines during Covid19 and health protocols existing in the community</li> </ul>	Contractor and workers for land clearing/ fencing	INEC's ESMP Focal Person and Safety Officer, NPC-PMO			
<ul style="list-style-type: none"> <li>Ensure compliance with applicable DOLE health and safety requirements;</li> </ul>		Contractor and workers for land clearing/ fencing					
<ul style="list-style-type: none"> <li>Provide appropriate PPEs to workers</li> </ul>		Contractor for land clearing/ fencing					
<ul style="list-style-type: none"> <li>Dispose of used face masks/shields in accordance with regulations</li> </ul>		INEC/PCO, Contractor and workers	INEC's ESMP Focal Person, NPC-PMO				
<ul style="list-style-type: none"> <li>Conduct relocation of poles/distribution line based on safety standards of ECs</li> </ul>		INEC Operations Group	INEC Safety Officer, NEA				
<ul style="list-style-type: none"> <li>Conduct health and safety orientation for the workers prior to start of activities at the site.</li> </ul>		INEC Safety Officer, Contractor for land clearing/ fencing	INEC's ESMP Focal Person, NPC-PMO				

		<ul style="list-style-type: none"> <li>Environmental contamination if wastes will not be properly managed</li> </ul>	<ul style="list-style-type: none"> <li>Dispose of garbage generated during site preparation in accordance with prescribed guidelines. No waste will be burned</li> <li>Segregate hazardous wastes from other wastes, store in a proper hazardous waste storage facility, and dispose of through a DENR-accredited transport/TSD service provider</li> </ul>	INEC's PCO, Contractor for land clearing/ fencing	INEC's ESMP Focal Person, NPC-PMO			
		<ul style="list-style-type: none"> <li>Possible issues on harassment, discrimination, abuse and related concerns among workers, and between community and workers</li> </ul>	<ul style="list-style-type: none"> <li>Set worksite rules and orient workers on these rules prior to implementation of activities</li> </ul>	INEC, Contractor for land clearing/ fencing	INEC's ESMP Focal Person, NPC-PMO			
			<ul style="list-style-type: none"> <li>Inform workers and the public about INEC's Grievance Redress Mechanism for resolving complaints/issues</li> </ul>	INEC				
			<ul style="list-style-type: none"> <li>Prioritize qualified persons from the community in the hiring of workers</li> </ul>	INEC, Contractor for land clearing/ fencing				
OPERATION	<ul style="list-style-type: none"> <li>Ground maintenance/ weeds Management</li> </ul>	<ul style="list-style-type: none"> <li>Safety risk to workers tasked to trim/remove weeds</li> </ul>	<ul style="list-style-type: none"> <li>Conduct safety orientation to workers</li> <li>Provide and require the workers to use PPEs all the time during the work</li> </ul>	INEC	INEC Safety Officer, NEA, DOE			
				Contractor for land clearing/ fencing				
		<ul style="list-style-type: none"> <li>Solar panel maintenance</li> </ul>	<ul style="list-style-type: none"> <li>Use of groundwater for cleaning of solar panels can reduce groundwater level</li> </ul>	<ul style="list-style-type: none"> <li>Implement water conservation measures</li> </ul>	INEC	INEC PCO, NWRB		
	<ul style="list-style-type: none"> <li>Operation and maintenance of solar PV system</li> </ul>	<ul style="list-style-type: none"> <li>Safety and health risk to facility workers</li> </ul>	<ul style="list-style-type: none"> <li>Comply with Renewable Energy Safety, Health and Environmental Rules and Regulations (RESHERR or DOE DC2012-11-0009 and DOLE OSH standards</li> </ul>	INEC	INEC Safety Officer, NEA, DOE, DOLE			



			<ul style="list-style-type: none"> <li>Follow DOLE Guidelines on Workplace Prevention and Control of COVID-19 and LGU/DOH Protocols</li> <li>Collect and dispose of used face masks in accordance with prescribed guidelines</li> </ul>					
		<ul style="list-style-type: none"> <li>Solid and hazardous wastes generated from the facility operation and workers' activities can contaminate soil and water</li> </ul>	<ul style="list-style-type: none"> <li>Collect, segregate, store and dispose of wastes in accordance with regulations</li> </ul>	INEC	INEC PCO, DENR			
DECOMMISSIONING	<ul style="list-style-type: none"> <li>Dismantling, removal from site, disposal of solar panels and associated equipment/facilities</li> </ul>	<ul style="list-style-type: none"> <li>Soil and water contamination due to hazardous materials from the solar PV/equipment</li> </ul>	<ul style="list-style-type: none"> <li>Preparation and implementation of decommissioning plan, including collection of used PC cells, proposed disposal methods, recycling opportunities</li> </ul>	Contractor for Decommissioning	INEC			
		<ul style="list-style-type: none"> <li>Soil disturbance due to removal of structures</li> </ul>	<ul style="list-style-type: none"> <li>Fill soil cavities and re-vegetate disturbed areas</li> </ul>	INEC				

Personnel in charge of ESMP implementation and monitoring: **ENGR. IAN G. RUGUIAN**

Prepared by:

  
**IAN G. RUGUIAN**  
 INEC Representative to ASEP-RNS

  
**FLEURDELIZ CREDO-TAYLAN**  
 INEC Representative to ASEP-RNS

Approved by:

  
**FELINO HERBERT P. AGDIGOS**  
 General Manager

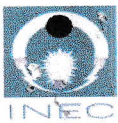

**MONITORING PLAN  
ASEP – RURAL NETWORK SOLAR PROJECT**

**PROPONENT: ILOCOS NORTE ELECTRIC COOPERATIVE, INC.**

Project Phase	Parameter to Monitor	Standards	Monitoring Frequency	Location	Responsibility for monitoring
Pre-construction to Decommissioning	Stakeholder engagements	<ul style="list-style-type: none"> <li>Coordination made with LGUs; community and other stakeholders are informed about the project by INEC/EPC Contractor</li> </ul>	<ul style="list-style-type: none"> <li>At least once prior to construction; as needed during construction up to decommissioning</li> </ul>	<ul style="list-style-type: none"> <li>LGU offices, government offices, community near project site</li> </ul>	NPC-Project Management Office (PMO), INEC's ESMP Focal Person
Site Preparation (Site Clearing & Fencing)	Cutting of trees	<ul style="list-style-type: none"> <li>Cutting of trees is coordinated by INEC with local DENR, and cutting permit secured, if required</li> </ul>	Once, during site clearing	Solar power plant project site	INEC's ESMP Focal Person, PMO
Site Preparation to Decommissioning	Disposal of wastes	<ul style="list-style-type: none"> <li>Construction debris, domestic garbage and hazardous wastes, including used face mask, are collected, properly segregated and disposed of by INEC and Contractor according to regulations.</li> <li>Hazardous wastes are stored in an appropriate hazardous waste storage facility and disposed of through DENR-accredited transport and treatment/recycling/ disposal service provider</li> <li>There is no burning of wastes</li> </ul>	Weekly and as necessary	Construction site and workers' accommodation	INEC's ESMP Focal Person and PCO, PMO
Site preparation to construction	Possible nuisance to nearby dwellers/ workers due to dust	<ul style="list-style-type: none"> <li>Water is sprayed by INEC/EPC Contractor on exposed soil/unpaved roads during dry weather, as needed</li> </ul>	As needed	Construction site	INEC's ESMP Focal Person, PMO
Construction	Runoff of sediment from the project site	<ul style="list-style-type: none"> <li>No or minimal runoff of sediment from the project site into drainage canals and adjacent properties</li> </ul>	As needed	Construction site	PMO, INEC's ESMP Focal Person
	Submission of required reports by Contractor	<ul style="list-style-type: none"> <li>Reports on compliance with CESMP, ECOP, Health &amp; Safety Manual, COHSP are submitted by EPC Contractor</li> </ul>	Quarterly	N/A	INEC's ESMP Focal Person and PCO, PMO
	Disposal of sludge & wastewater from portable toilets	<ul style="list-style-type: none"> <li>EPC Contractor has a valid contract with DENR/DOH accredited sewage transport/ treatment firm for the duration of solar power plant construction</li> </ul>	Once, prior to construction	N/A	
		Sludge transporter/treatment facility has a valid Environmental Sanitation Clearance from DOH and ECC from the DENR	Once, prior to construction	N/A	
	Transporter ensures that sludge transport is accompanied by properly filled-out prescribed Manifest Form	Every desludging activity	N/A		



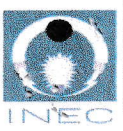

**ILOCOS NORTE ELECTRIC COOPERATIVE, INC.**

Suyo, Dingras, Ilocos Norte 2913

(077) 676-4632 | (077) 676-1306 | (077) 784-7125 (fax) | inec\_main@yahoo.com

	Quarry Permit	EPC Contractor secures copy of valid Quarry Permit from the supplier of sand/ gravel used in the project	Prior to procurement of the materials	N/A	PMO, INEC's ESMP Focal Person
Construction and Operation	PPEs	Workers wear appropriate PPEs, including face masks for Covid19	Random site inspection	Project/Solar Power Plant Site	PMO, INEC's Safety Officer and ESMP Focal Person
	Safety signage	Signage are placed in appropriate places by EPC Contractor/INEC	Random site inspection		
	Work-related accidents	Zero accident	Daily		
	Covid19 cases at project site	No personnel is infected with Covid19	Daily		
	Training/ orientation of personnel	Workers undergo orientation/ training on environmental, health and safety conducted by EPC Contractor	Once, or more as needed, prior to construction/ deployment of workers. To be conducted also whenever there are new workers.		
Construction and Operation	Proper housekeeping	Work and accommodation areas are clean and orderly	Random site inspection	Work and accommodation areas	INEC's ESMP Focal Person, PMO
Construction to Post-Construction	Re-vegetation of disturbed areas	Landscaping and re-vegetation of disturbed areas are implemented by INEC	At least once upon completion of construction	Project site	PMO, INEC's ESMP Focal Person
		Trees of native species are planted in the vicinity of the project site, if applicable, to replace removed trees		Project site (if applicable), vicinities or other areas in identified with DENR	PMO, INEC's ESMP Focal Person
Pre-construction to Decommissioning	Grievances/ Complaints	No or few and minor project-related complaints filed with INEC or EPC Contractor	Weekly	Project site	INEC's ESMP Focal Person and Grievance Officer, PMO
		Complaints are resolved within 15 days			
Decommissioning	Site restoration	Soil cavities resulting from structure removal are backfilled and soil properly compacted; disturbed areas are re-vegetated	Weekly, as applicable to schedule of works	Solar power plant site	INEC

Prepared by:

  
**IAN G. RUGUIAN**  
 INEC Representative to ASEP-RNS

  
**FLEURDEUZ CREDO-TAYLAN**  
 INEC Representative to ASEP-RNS

Approved by:

  
**FELINO HERBERT P. AGDIGOS**  
 General Manager



**MITIGATION COST\*  
ASEP – RURAL NETWORK SOLAR PROJECT**

**PROPONENT: ILOCOS NORTE ELECTRIC COOPERATIVE, INC.**

ASPECT		MITIGATION ACTION	COST	IN-CHARGE/ RESPONSIBLE
1	Health and Safety	PPEs for COVID-19 (face masks, face shield, etc.), disinfectant	P150,000.00	INEC Representatives to ASEP-RNS  INEC's Safety Officer  INEC's PCO
		PPEs during site clearing/fencing (hard hat, gloves, etc.)		
2	Information Campaign	Leaflets, posters, billboards, etc.	P50,000.00	
		Meeting with LGUs and Public Hearings		
3	Soil erosion due to site clearing/earthworks	Landscaping	P100,000.00	
		Tree planting		
4	Disposal of hazardous wastes (if any)	Segregation, storage in a hazardous waste facility and disposal through DENR-accredited transport and treatment/ disposal firm	P 50,000.00	
5	Training	BOSH Training for Safety Officer (SO)	P20,000.00	
		Basic Pollution Control Officer's (PCO) Training	P20,000.00	
6	Permitting requirements	SO accreditation fees (DOLE-BWC)	P1,000.00	
		PCO accreditation fees with training (DENR-EMB)	P20,000.00	
		CNC fees	P1,140.00	
		Development Permit fees	<i>To be determined</i>	
		Locational Clearance fees	P10,000.00	
		CNO fees	P150.00	
<b>TOTAL</b>			<b>₱ 422,290.00</b>	

\* For pre-construction, site preparation, solar power plant operation

Prepared by:

**IAN G. RUGUIAN**

INEC Representative to ASEP-RNS

**FLEURDELIZ CREDO-TAYLAN**

INEC Representative to ASEP-RNS

Approved by:

**FELINO HERBERT P. AGDIGOS**

General Manager





# ILOCOS NORTE ELECTRIC COOPERATIVE, INC.

Suyo, Dingras, Ilocos Norte 2913

(077) 800-4632 | (077) 676-1306 | (077) 784-7125 (fax) | inec\_main@yahoo.com



12 November 2020

## ***To Whom It May Concern:***

This is to certify that the Ilocos Norte Electric Cooperative, Inc. (INEC) hereby follows the herein grievance procedure relative to grievances and/or complaint of our consumers and other third parties involving our operation, to wit:

### ***I. FILING OF WRITTEN COMPLAINT***

- i. Any aggrieved party may file his/her written Complaint to the Office of the General Manager, INEC Main Office, Brgy. Suyo, Dingras, Ilocos Norte, anytime from the occurrence of the matter or issue being complained of OR to any of the sub-offices of INEC located in the following addresses, to wit:
  - a) Area 2 - Laoag Sub-Office, Brgy. 23 Vintar Road, Laoag City;
  - b) Area 3 - Batac Sub-Office, Brgy. Lacub. Batac City;
  - c) Area 4 - Bangi Sub-Office, Brgy. Masikil, Bangui, Ilocos Norte;
  - d) Area 5 - Sarrat Sub-Office, Brgy. San Joaquin, Sarrat, Ilocos Norte; and
  - e) Area 6 - San Nicolas Sub-Office, Brgy. 23 San Marcos (Payas), San Nicolas, Ilocos Norte;
- ii. Any aggrieved party may directly contact the National Power Corporation - Project Management Office (ASEP) for any concern regarding the project.
- iii. The Complaint must contain a complete statement of the acts, omissions or rights omitted or violated specifically stating therein the place, time, date and personnel involved.

### ***II. ACTING ON THE COMPLAINT***

- i. Within three (3) days from receipt of the written Complaint, the General Manager shall forward the Complaint to the concerned Department/Area Manager for proper disposal and/or investigation, whichever is deemed appropriate on the nature of the Complaint; and





# ILOCOS NORTE ELECTRIC COOPERATIVE, INC.

Suyo, Dingras, Ilocos Norte 2913

(077) 600-4832 | (077) 676-1306 | (077) 784-7125 (fax) | [inec\\_main@yahoo.com](mailto:inec_main@yahoo.com)



- ii. The concerned Department/Area Manager will conduct an investigation relative to the complained act, omission or violated right and make a Report within fifteen (15) days from receipt of the Complaint. The concerned Department shall exhaust all means to resolve the Complaint but in no case shall be against any law, morals, good customs, public order or public policy.

### III. **RESOLUTION OF THE COMPLAINT**

- i. Within the period given to the concerned Department to investigate and make a Report on the Complaint, it shall forward its Report to the Office of the General Manager for his review, comment and/or approval; and
- ii. Once the Report is approved by the General Manager, the Complainant shall be notified of the result of the investigation thru a meeting/conference with the presence of the Complainant/s. Once the Complainant accepts the approved Report/Resolution or if a settlement is availed of, the same shall be complied with within a period commensurate to the gravity or nature of the compliance.

### IV. **WHEN NO RESOLUTION OR COMPROMISED SETTLEMENT IS REACHED**

- i. If no settlement is reached or made within the jurisdiction of INEC, the complaint shall be appealed and/or elevated to the National Power Corporation (NPC) for reconsideration.

The foregoing is hereby issued as a requirement of the ASEP-RNS Solar Project in Currimao, Ilocos Norte only. Given this 12<sup>th</sup> day of November 2020 at Brgy. Suyo, Dingras, Ilocos Norte.

  
**FELINO HERBERT P. AGDIGOS**  
General Manager